



Table of Contents

Table of Contents 1

Compatibility (Freestanding Models Only) 1

Packing List 1

Operating Instructions 1

Installation Instructions (All Except Leyden, Arbor, and 1750)..... 1

1750 Installation Instructions 4

Leyden and Arbor Installation Instructions (Rev 005 or Later – See Note Below) 5

Compatibility (Freestanding Models Only)

- Lopi Answer • Lopi Endeavor • Lopi Liberty • Lopi Leyden
- Avalon Pendleton (745/790) • Avalon Rainier (945/990) • Avalon Olympic (1190) • Avalon Arbor
- 1250 Wood Stove • 1750 Wood Stove

Packing List

- Rear Blower
- Snap Disk Assembly
- Snap Disk Hanger
- (3) 1/4" 20 Thread Cutting Screws
- Rheostat Mounting Bracket
- (2) M8 Bolts (used for Arbor/Leyden only)

Operating Instructions

The blower will not turn on until the appliance is up to temperature. Once up to temperature, the blower will operate at the speed determined by the position of the blower knob (see the illustration below). The blower will shut off once the appliance cools.



Installation Instructions (All Except Leyden, Arbor, and 1750)

1. Install the stove legs or pedestal. Remove the two rear blower knock-outs underneath the base (see the illustration below).

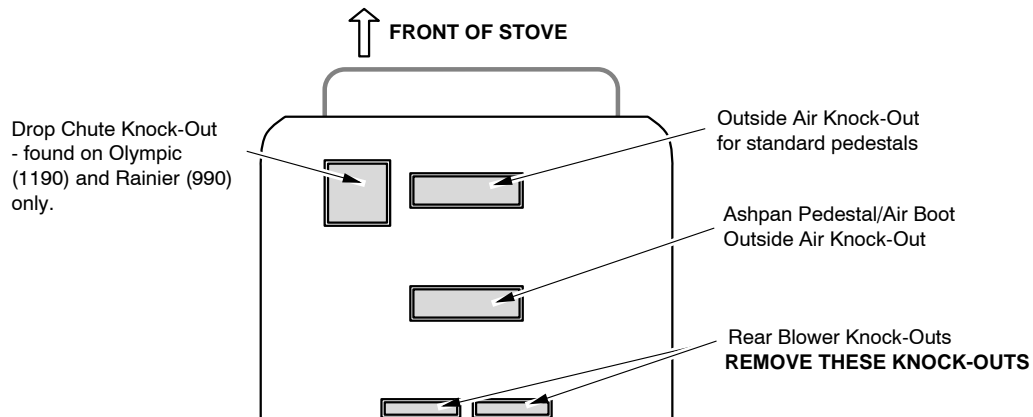



Wood Stove Rear Fan 2 Installation Instructions

99000118

2. Install the snap disk assembly.

NOTE: For the Endeavor and Liberty follow step 2B. For all other models, follow step 2A.

2A Install the snap disk assembly into the left side convection chamber following the directions below.

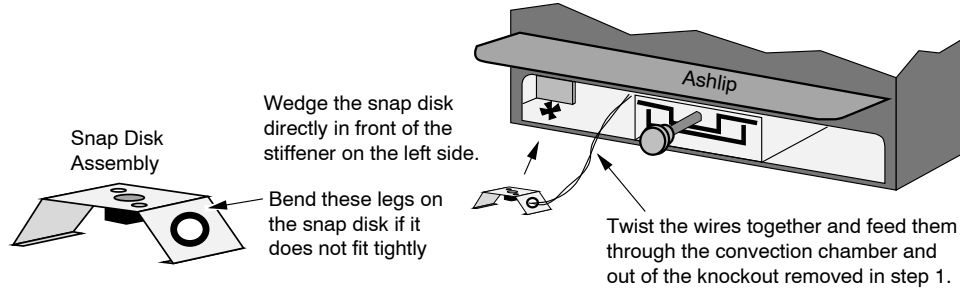

2A Secure the snap disk wires in place following the directions below. Go to step 3.

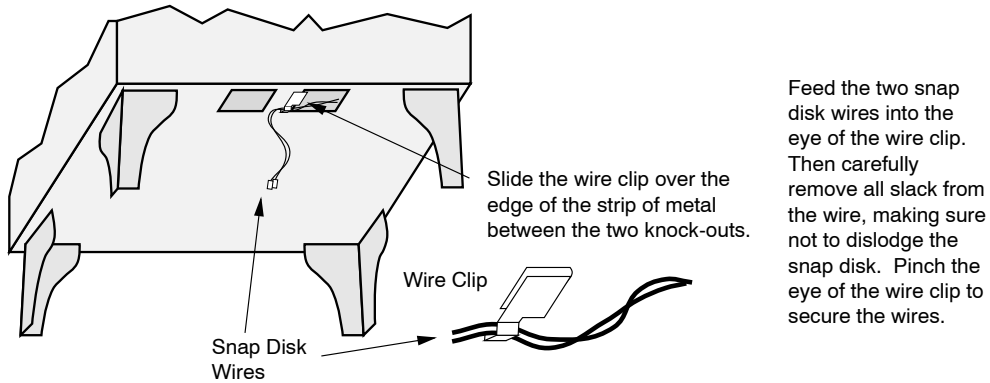

NOTE: The wires must be properly secured to prevent them from contacting the firebox and shorting out the blower circuit.

2B (Liberty, Endeavor only)

Install the snap disk assembly inside the heat shield following the directions below. Secure the snap disk wires in place following the directions below.

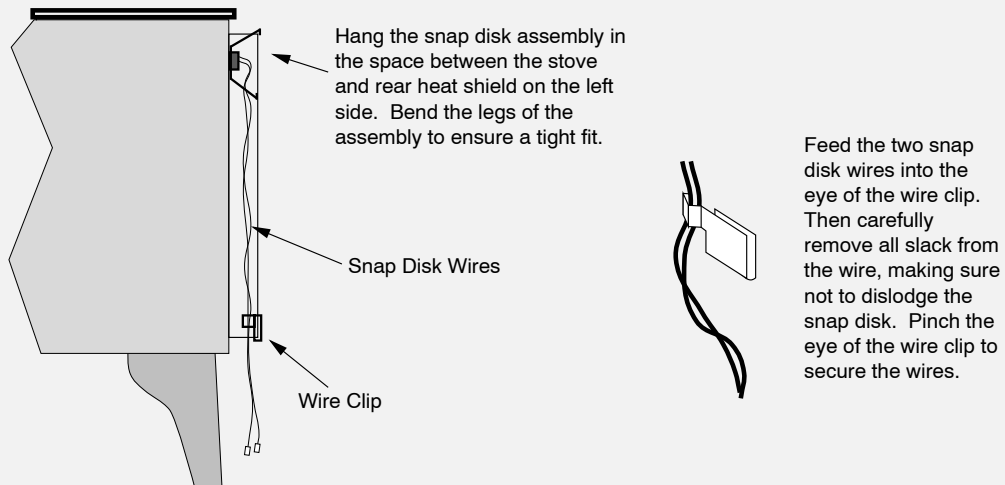

Secure the snap disk wires in place following the directions below.

NOTE: The wires must be properly secured to prevent them from contacting the firebox and shorting out the blower circuit.



Wood Stove Rear Fan 2 Installation Instructions

99000118

- Place the blower near the bottom rear edge of the stove. Attach the quick-connects from the snap disk assembly to the quick-connects on the blower. Push any slack wire into the blower box. Attach the blower following the directions below.
- Attach the rheostat and rheostat mounting bracket to the underside of the stove, behind the left front leg. Magnets hold it in place.

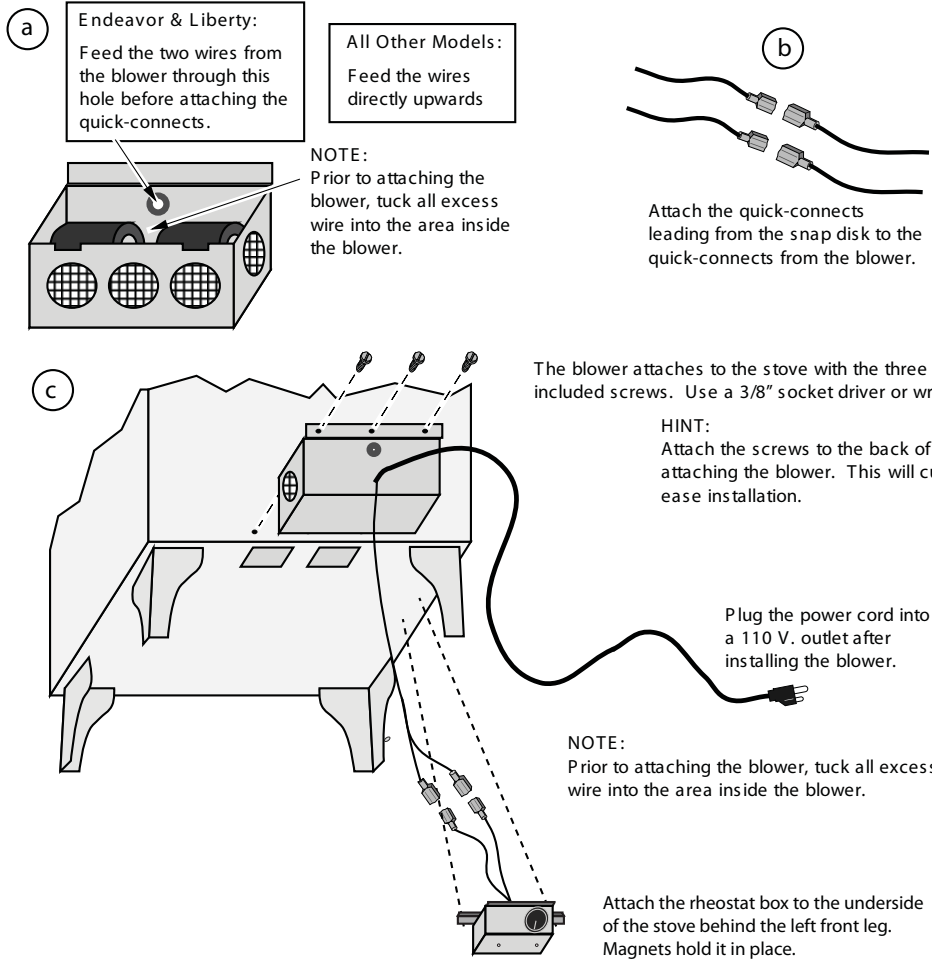

The blower is shown in the photo below.

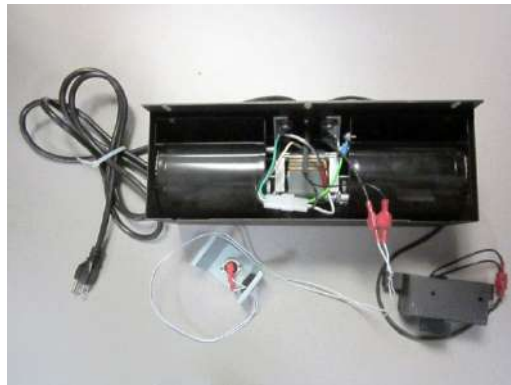



Wood Stove Rear Fan 2 Installation Instructions

99000118

1750 Installation Instructions

- (a) Remove these two knock-outs on the bottom of the stove (use a screwdriver to pry them out).

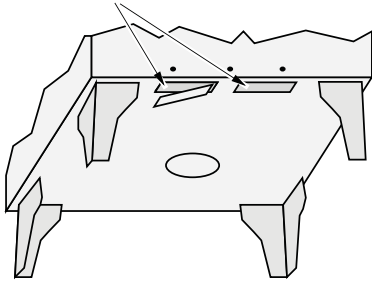

- (b) Place the snap disk assembly over the snap disk extender (included with the stove) and bend these tabs to secure.

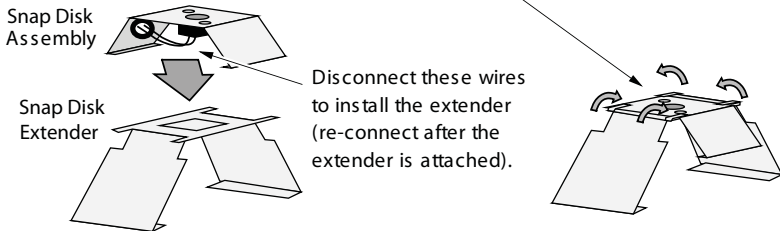

- (c) Wedge the snap disk into the convection channel. Bend the legs on the extender, if necessary, so the snap disk contacts the firebox.

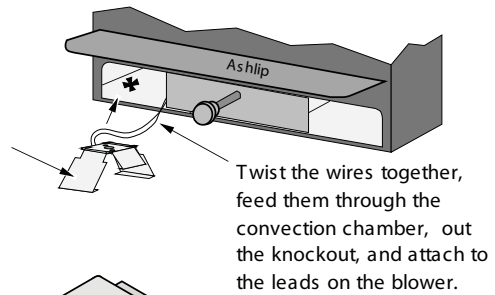

- (g) Attach the blower to the stove with the three screws included with the blower.

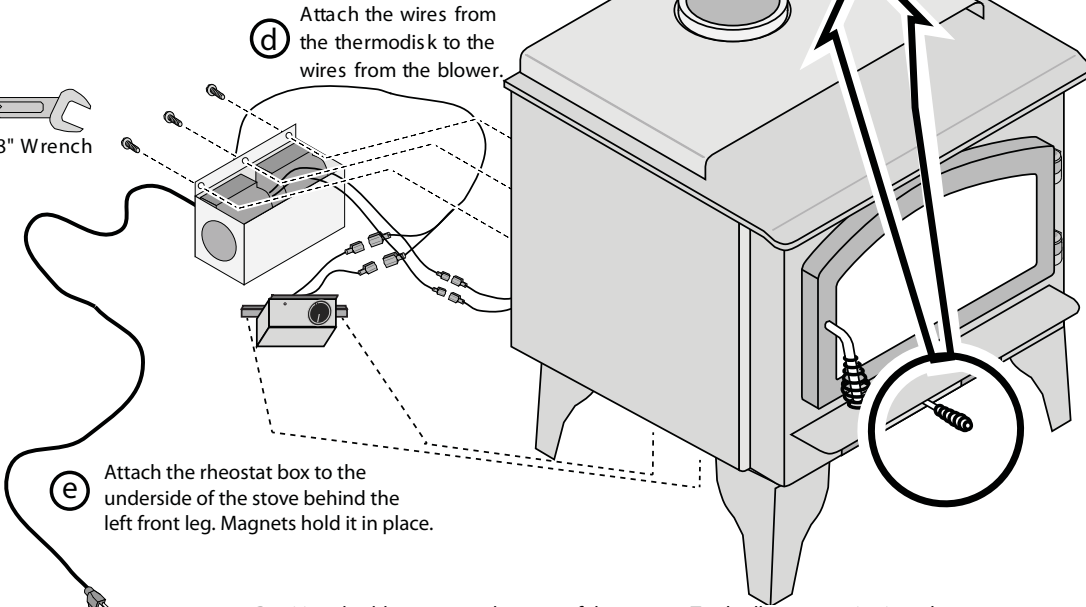

- (h) Plug the blower in. Do not route the power cord under or over the stove or in a location where it may become damaged.



Wood Stove Rear Fan 2 Installation Instructions

99000118

Leyden and Arbor Installation Instructions (Rev 005 or Later – See Note Below)

NOTE: If you have a Leyden or Arbor Rev 004 or earlier (last built in July, 2010), you will need to slide the included snap disk into the convection chamber behind the flue and route the wire externally to the blower.

The following instructions are for Leyden and Arbor wood stoves with the built in thermodisk (serial # 1110-009120 or greater for Leyden, serial # 1307-003086 or greater for Arbor).

